

Varenummer: 40550300241230
 Beskrivelse: Tandhjulsgear S301P-2,4-P80B5

Mål

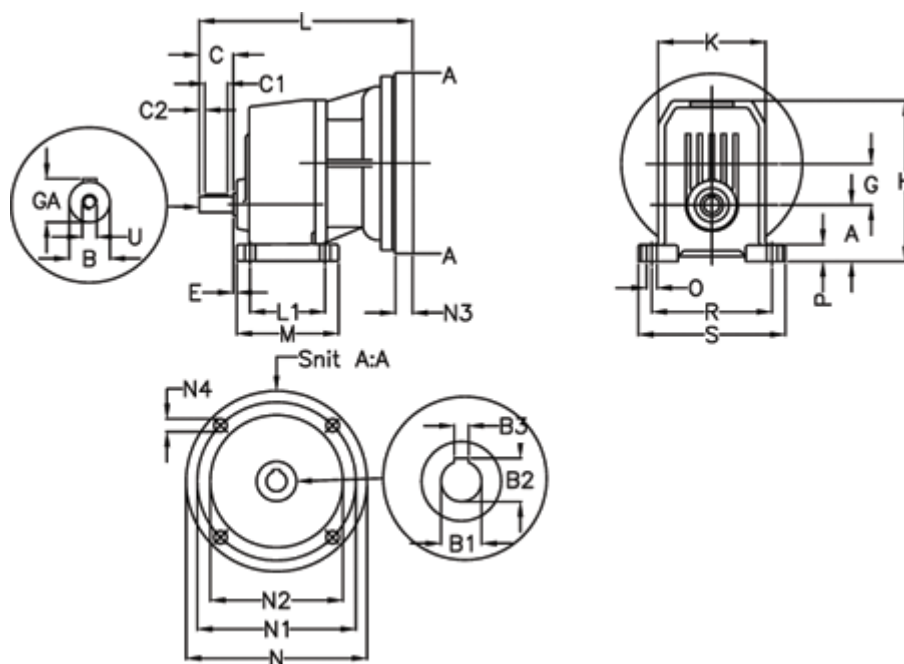

A = 60	E = 20.5	M = 125.0	R = 160
B = 24	F = 8x7x40	N = 200	S = 190
B1 = 19	G = 51.8	N1 = 165	U = M8
B2 = 21.8	GA = 27.0	N2 = 130	
B3 = 6	H = 183.0	N3 = -	
C = 50	K = 130	N4 = M10x12	
C1 = 40	L = 252	O = 11	
C2 = 5	L1 = 90.0	P = 20.0	